



# W10 Adjustable Autotransformers

## GENERAL INSTRUCTIONS

**1.1 LINE VOLTAGE AND FREQUENCY.** The W series autotransformers are designed for use at a minimum frequency of 50 cycles per second (c/s) for the stated line voltage (120 V for standard models, 240 V for Type H models). They can be operated successfully at frequencies as high as 400 c/s, but the line-voltage ratings should not be substantially exceeded. At frequencies above 400 c/s, the use of M series models is recommended. (These models are expressly designed for operation at frequencies above 350 c/s.) The Type H models can be operated from a 120-volt, 25-cycle line, but must be connected as for 240-volt, 60-cycle operation. Current ratings remain unchanged, but the power rating is reduced by a factor of 2, due to half-voltage operation.

Autotransformers cannot be operated on direct current. Any attempt to do so will result in a burned-out unit.

**1.2 FUSES AND LINE CAPACITY.** Protect your unit by placing a fusing device of proper rating between terminal 3 and the load. The input line capacity must be adequate for the autotransformer, its load, additional loads that may be required, and a margin for slight overload. Because these transformers are iron-core devices using high-performance core material, normal inrush surges up to 10 times the rated current of the unit may be encountered when it is first connected to the line. Fuses must be selected with this in mind.

Slow-blow (thermal delay) fuses or magnetic or thermal time-current integrating breakers are preferable to the quick-blow fuse, for the input line and the load circuits. Type MT models are equipped with a thermal breaker in the load circuit to protect the unit from accidental overload. *This practice may wisely be applied to other models by the user by the insertion of a protective device of proper rating between terminal 3*

and the load. Such devices as Klixon and Heinemann circuit breakers are particularly useful where the load is subject to high inrush.

The short-term overload curve, Figure 1, shows what your autotransformer will stand under initial surge conditions, as in motor starting, incandescent lamp lighting, etc. At no time should the unit be called upon to furnish a current in excess of ten times its rated current.

**1.3 LOADS.** Autotransformers are adaptable to any load that is subject to control by voltage variation. As a rule, induction motors cannot thus be smoothly controlled. However, dc motors (with rectifiers), universal motors (with or without rectifiers), capacitor motors with fan loads, heaters, lights, and many other devices are suitable for such control.

The overvoltage connection should be avoided where the load may be damaged by the higher-than-line voltage available. When the overvoltage connection is omitted, with a fixed, known load, maximum current can be drawn at line voltage. Since losses (which vary with brush setting) are at a minimum near line and zero voltages, higher current can be drawn at these settings without exceeding normal temperature ratings. This higher (maximum) current is of such value that, as the brush setting is reduced below line voltage, with a constant-impedance load, the current fall-off with decreasing output voltage keeps the current within safe limits. To find the impedance in ohms of the minimum ohmic load, divide line volts by maximum amperes. The power rating of this load in watts is the product of line volts and maximum amperes.

For continuous operation, the rated current of the transformer should not be exceeded. Derate the unit in accordance with Figure 2 for ambient temperatures above 50 C.

Figure 1. Overload limits for line-voltage connection.

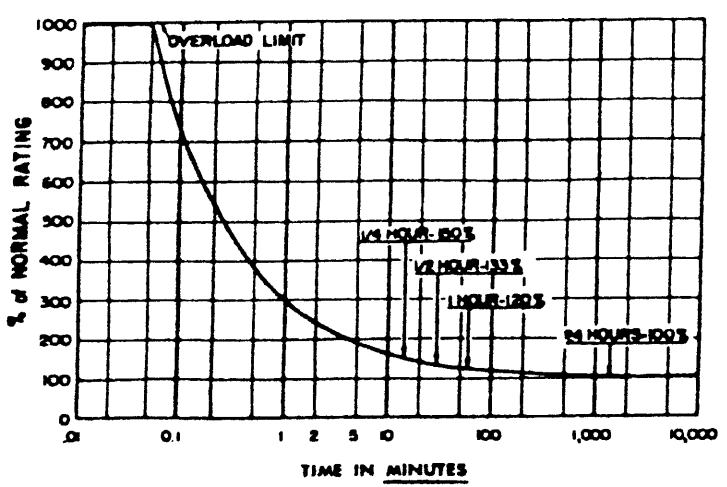
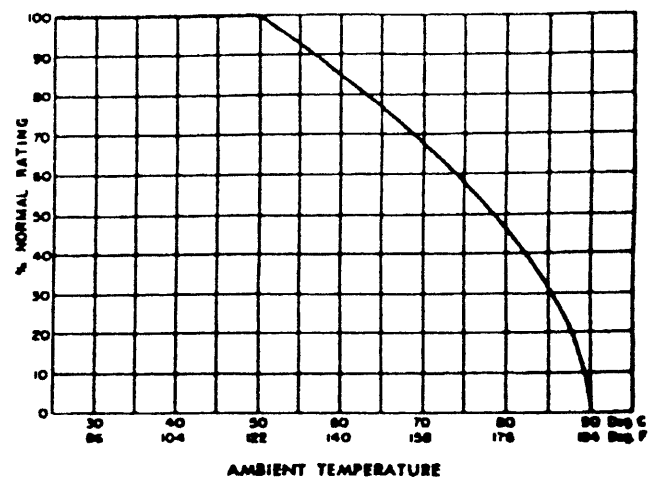

Figure 2. Temperature derating curve.



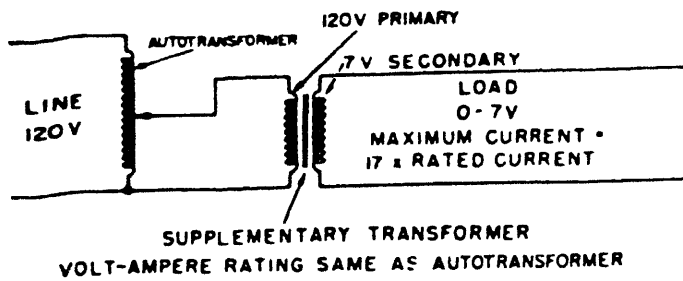

Figure 3. Supplementary low-voltage transformer useful for applications such as control of vacuum-tube heaters.

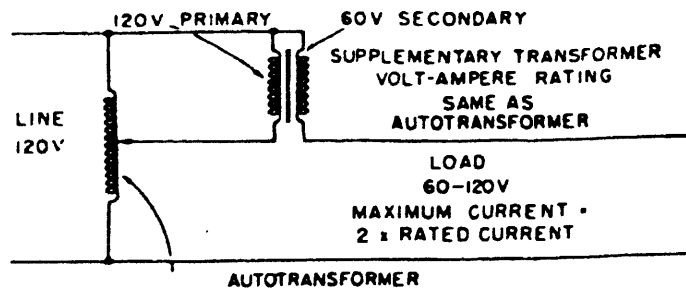

Figure 4. Supplementary 2:1 transformer useful for applications such as control of resistance furnaces.

When a load requires regulation over a limited range only, a supplementary, fixed, step-down transformer gives more satisfactory and economical operation. This practice results in:

- an increase in current rating in the ratio of line voltage to operating range.
- finer adjustment, since the operating range is spread out over the entire winding.
- longer unit life, as the brush traverses the entire winding rather than a limited arc.

Typical examples are illustrated in Figures 3 and 4.

**1.4 SWITCHING** To avoid dangerous surges, always set the pointer to zero before switching in the load circuit.

#### 1.5 MAINTENANCE.

##### WARNING

Always disconnect the autotransformer from *both* sides of the line before attempting any maintenance work.

**1.5.1 BRUSH TRACK.** The brush track is stabilized by the contact surface. If cleaning becomes necessary use only a soft cloth and a safe solvent such as alcohol or "white" (non-leaded) gasoline. Do not use abrasives; their action may destroy the stabilized surface.

**1.5.2 BRUSHES.** Normally, brushes will last indefinitely. Rapid brush wear is an almost certain sign of overload, although the presence of an abrasive dust can accelerate

wear of both brush and brush track. Brush extension is limited to prevent contact between the metal brush shell and the winding. Operation of the brush beyond its extension limit results in arcing, indicated by a voltage drop under load. Replace brushes before this limit is reached.

Types W10 and W10M use the Technipower Type VBT-10 brush assembly. Types W10H and W10HM use the Technipower Type VBT-11 brush assembly. To replace this assembly, remove the two screws that secure the brush assembly. Be sure the "pigtail" on the new assembly is securely fastened under the mounting screws. Newly installed or reinstalled brushes must be correctly seated for proper operation. With power off, a few swings of the brush over the abrasive side of a piece of crocus cloth resting on the brush track will effectively mate brush and track. Remove the crocus cloth and blow or brush loose carbon from the brush track before applying power.

**1.6 SERVICE.** If, for any reason, you feel that your unit does not operate properly, write to our Service Department, giving operating details, circuit diagram, input and output voltages and currents, and load type and rating.

When returning a unit for repair, or for any other reason, please write to our Service Department first, requesting shipping instructions. State the type number and the date of purchase. Pack the unit carefully. Returned units often suffer more damage in shipment than in service.

## SPECIFICATIONS

Type No.	INPUT		OUTPUT				60-cycle No-load Watts	Driving Torque Ounce-Inches	Net Weight Pounds
	Volts	c/s	Volts	Rated Amp	Max Amp	Max KVA			
W10	120	50-60	0-120 0-140	10 10	13 10	1.56 —	17	15-30	12 1/2 (5.7 kg)
W10M	120	50-60	0-120 0-140	10 10	13 10	1.56 —	17	15-30	15 1/2 (7.0 kg)
W10MT W10MT3	120	50-60	0-120 0-140	10 10	13 10	1.56 —	17	15-30	16 (7.3 kg)
W10H W10HM	240 240 120 120 120	50-60 50-60 50-60 25 25	0-240 0-280 0-280 0-120 0-140	4 4 2 4 4	5.2 4 2 5.2 4	1.25 — — 0.62 —	17	15-30	12 (5.4 kg) 14 1/2 (6.6 kg)
W10HMT W10HMT3	240 240 120 120 120	50-60 50-60 50-60 25 25	0-240 0-280 0-280 0-120 0-140	4 4 2 4 4	5.2 4 2 5.2 4	1.25 — — 0.62 —	17	15-30	15 1/2 (7.0 kg)

Surface Mounting

(TERMINALS 6 AND 7 PRESENT ON H MODELS ONLY)

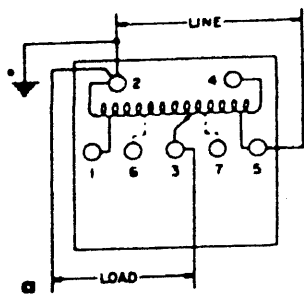

W10 { LINE: 120 volts, 50 to 60 cps  
LOAD: 0-140 volts

W10H { LINE: 240 volts, 50 to 60 cps  
LOAD: 0-280 volts

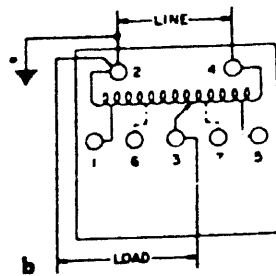

W10 { LINE: 120 volts, 50 to 60 cps  
LOAD: 0-120 volts

W10H { LINE: 240 volts, 50 to 60 cps  
LOAD: 0-240 volts

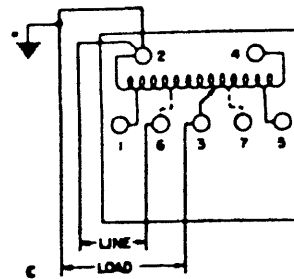

W10H { LINE: 120 volts, 50 to 60 cps  
LOAD: 0-200 volts

Surface Mounting

(TERMINALS 6 AND 7 PRESENT ON H MODELS ONLY)

Back-of-Panel Mounting

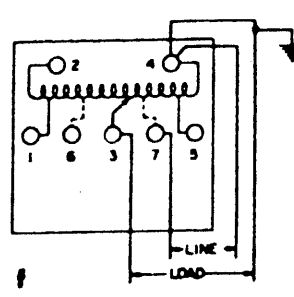
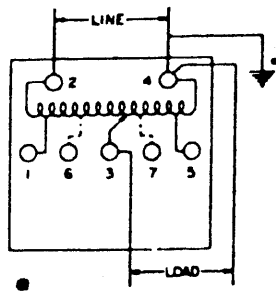
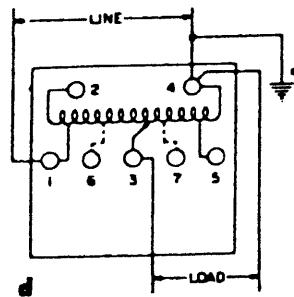

Back-of-Panel Mounting

\*If ground is necessary, common line-load terminal must connect to ground side of line.

Figure 5. Recommended line and load connections to the autotransformer.

## TYPES W10 and W10H AUTOTRANSFORMERS

**2.1 GENERAL.** The basic Types W10 and W10H autotransformers are uncased units for back-of-panel mounting, with combination screw and solder-lug terminals provided. Figure 6 may be used as a drilling template.

**2.2 THREE-HOLE MOUNTING.** The drilling template may be used directly to lay out the three unit mounting holes, three dial-plate mounting holes, and the shaft clearance hole. The mounting screw heads must be flush or subflush with the panel surface to avoid interference with the dial plate.

**2.3 FOUR-HOLE MOUNTING.** The drilling template may be used directly to lay out the four unit mounting holes, three dial-plate mounting holes, and the shaft clearance hole. The four mounting screws do not require countersinking or counterboring, since there is sufficient clearance for the dial plate. Be sure the base is flat against the panel. Do not overtighten any of the mounting screws, as this may distort or tip the base.

**2.4 GENERAL MOUNTING INFORMATION.** Excellent

heat-transfer characteristics exist between the coil and base and between the base and panel. A marked reduction in operating temperature can be realized if there is good thermal contact (tight parallel mounting) between the base and a metal mounting panel of any substantial area. It is recommended that the unit be installed where adequate ventilation is available, and well away from hot instruments. In mounting the reversible dial plate, use the scale that conforms to the load voltage range of the selected wiring connections. To adapt shaft projection for various panel thicknesses (1/2" maximum with standard shaft), loosen the two setscrews in the radiator hub, move the shaft as required, and retighten the setscrews. Longer shafts are available at slight extra charge, and should be used on panels thicker than 1/2". The shaft should project not less than 3/16" from the radiator hub to allow adequate overinsulation distance between hub and shaft core. The pointer should be at zero with full counterclockwise rotation.

**2.5 WIRING.** Two wiring circuits are available, as shown in Figure 5d, e, or f. When making connections, avoid loose "whiskers" and keep wiring free from contact with working parts.

## TYPES W10M and W10HM AUTOTRANSFORMERS

**3.1 GENERAL.** The Types W10M and W10HM models are cased units for either surface or back-of-panel mounting with BX or conduit connections. (See Figure 7.)

**3.2 SURFACE MOUNTING.** The procedure for surface mounting is as follows:

- Remove the slotted screw on top of cover, and the knob.
- Swing the cover away and down. Remove cover.
- Fasten the unit to the supporting structure with four

woodscrews, machine screws, or bolts, passing through the base and case and into or through the support.

d. Remove knockouts as required by striking sharp blows with a hammer and screwdriver on the sides of the knockout where the metal has been sheared, and twisting the knockout. Do not strike at the small metal ties and do not pry. Wire according to circuit a, b, or c shown in Figure 5. See directions for dial plate mounting given with circuit diagram.

e. Check wiring for accuracy and for clearance of live parts.

f. Replace the cover and knob. Align the pointer so that it is at zero with full counterclockwise rotation.

**3.3 BACK-OF-PANEL MOUNTING.** The procedure for back-of-panel mounting is as follows:

- a. Remove the slotted screw on top of cover, and the knob.
- b. Swing the cover away and down. Remove cover.
- c. Loosen the setscrews in the radiator hub, and push the shaft to project through the panel. Maximum panel thickness with standard shaft is  $\frac{1}{2}$ ". Longer shafts are available at slight extra charge, and should be used on panels thicker than  $\frac{1}{2}$ ". The shaft should project not less than  $\frac{3}{16}$ " from the radiator hub to allow adequate overinsulation distance between hub and shaft core.
- d. Remove the dial plate for later mounting on the panel.
- e. Mount the nameplate over the shaft hole, if desired. Holes are provided for this purpose.
- f. Drill the panel in accordance with template directions (Figure 6). Provide holes for dial mounting and shaft

clearance.

- g. Mount the unit on the rear of the panel.
- h. Attach the dial plate to the front of the panel, with the self-tapping screws that initially fastened the dial plate. Use the voltage scale appropriate to the connections.
- i. Attach the knob on the front of the panel. Tighten the setscrews in the radiator hub, setting pointers at zero with full counterclockwise rotation.
- j. Remove knockouts as required by striking sharp blows with a hammer and screwdriver on the side of the knockout where the metal has been sheared, and twisting the knockout. Do not strike at the small metal ties and do not pry. Wire according to circuit d, e, or f, Figure 5.
- k. Check wiring for accuracy and for clearance of live parts.
- l. Replace the cover.
- m. Autotransformers are usually mounted with the long axis vertical and terminal plate up. If required for wiring convenience or because of space limitations, the long axis may be horizontal, or terminal plate down. In all cases the dial should be oriented for convenience in reading.

## TYPES W10MT, W10MT3, W10HMT and W10HMT3 AUTOTRANSFORMERS

**4.1 GENERAL.** The Types W10MT and W10HMT models are cased (totally enclosed) units that include a power cord and plug, and OFF-ON switch that switches both side of the line, an outlet plug for the connection of the load, a manual reset overload protector, and a carrying handle. The Type MT models are designed for use in laboratories, industrial plants, and other locations where a portable ac voltage-adjusting device of high efficiency is required.

The types W10MT3 and W10HMT3 models have a third circuit in the power cord and plug and in the load outlet. This circuit is a safety feature to provide for automatic grounding of the unit and load enclosures, to reduce the hazard of shock, should line-circuit parts accidentally contact the cases or frames.

**4.2 OPERATION.** The operating procedure is as follows:

- a. Connect the power plug to a line of proper voltage and frequency, as determined from the nameplate.
- b. With the switch OFF and the pointer set to zero, connect the load. The load should be able to withstand the highest output voltage contemplated, and should at no setting draw more than the rated current.
- c. To apply voltage to the load, turn the switch ON and advance

the pointer setting to the desired value. Operation is unaffected by the position of the transformer.

d. Type MT models are normally wired for overvoltage output (Figure 5d), and are supplied equipped with an overvoltage dial. They can be supplied on special order with line-voltage output (Figure 5e) and a dial for this connection, at a slight extra cost. Type HMT models may be reconnected for 120-volt input as shown in Figure 5f (280-volt output).

e. Overload protection is provided by a thermal trip device, which disconnects the load under conditions that might cause the safe operating temperature to be exceeded. The thermal capacity is sufficient to allow moderate short-time overloads that will not harm the unit. After correcting the overload condition, reset the tripped connector by pressing the red reset button. Make sure that the protector has had time enough to cool. The circuit breaker is set according to rated current, and therefore will not function when a Type W10HMT model is connected as shown in Figure 5f, since these connections cause a 50-per cent reduction in rating.

f. To gain access to moving parts for maintenance, disconnect the power cord, remove the four slotted screws, and pull the cover out and off.

**VARIAC**



**IET LABS, INC.**

534 Main Street

Westbury, NY 11590

www.ietlabs.com 516-334-5959 F:516-334-5988

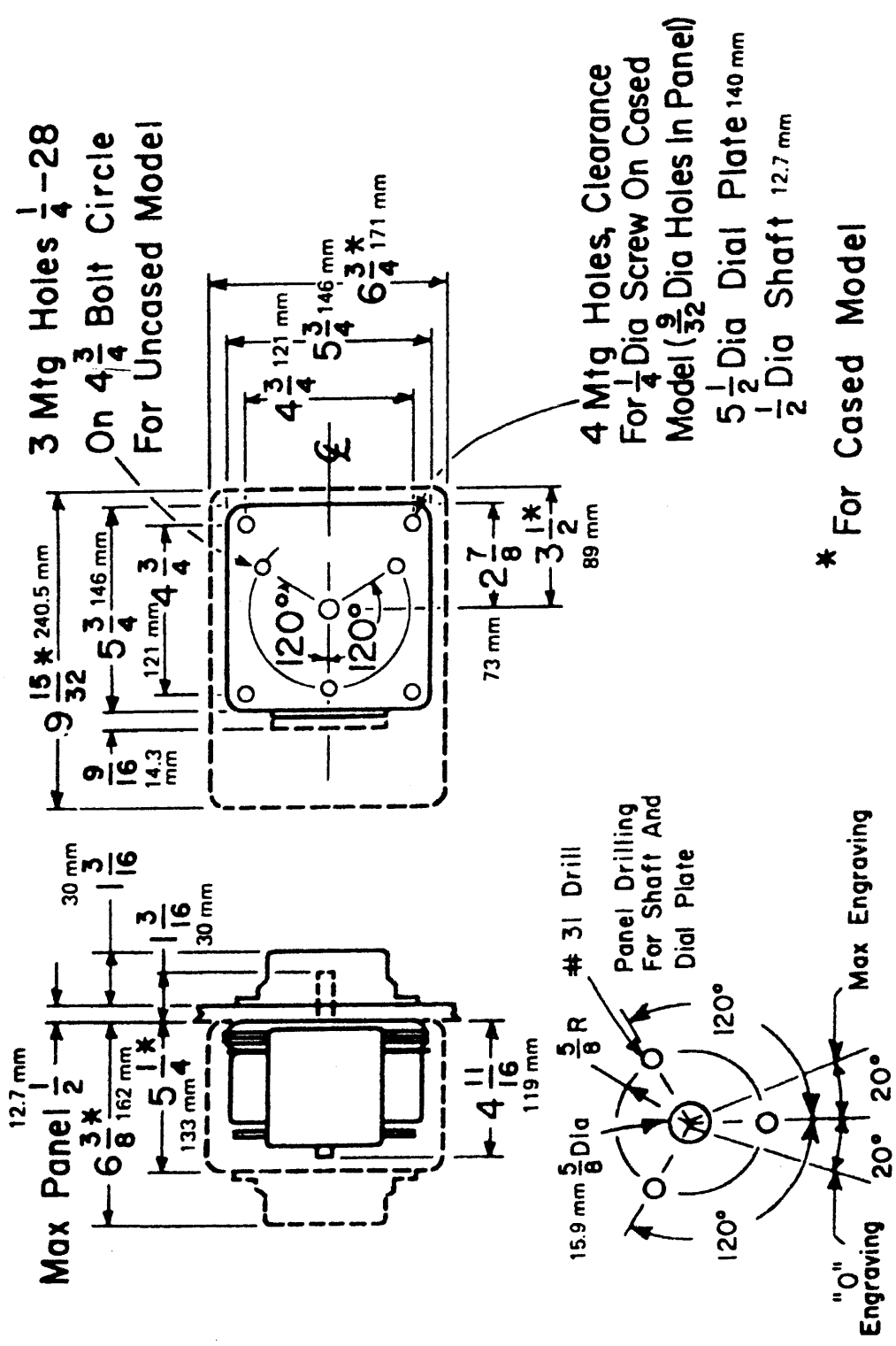

Figure 7. Dimensions of Types W10 autotransformers.